

**CURBSIDE VIEW**

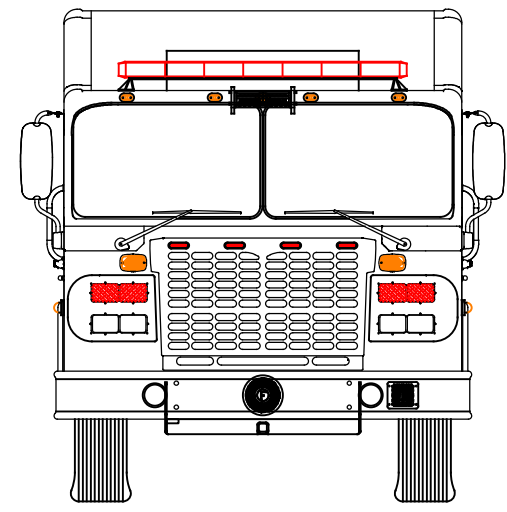

**FRONT VIEW**

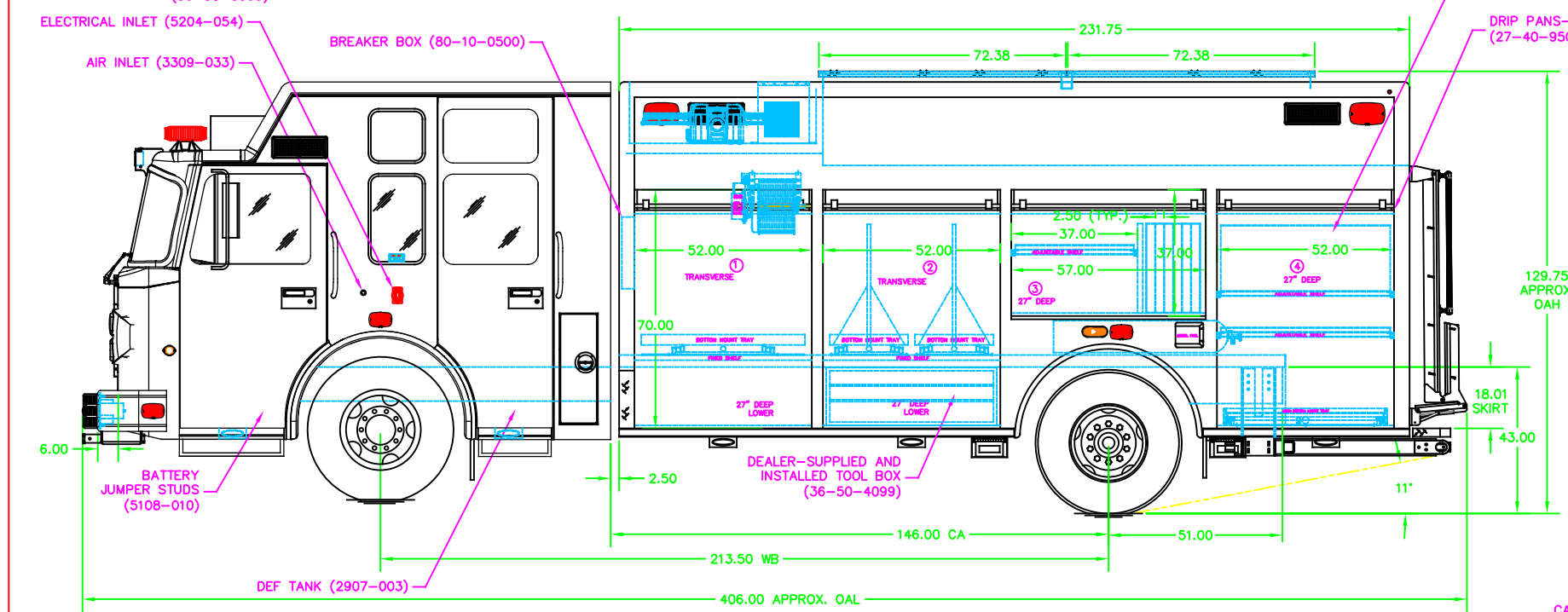

**DRIVERSIDE VIEW**

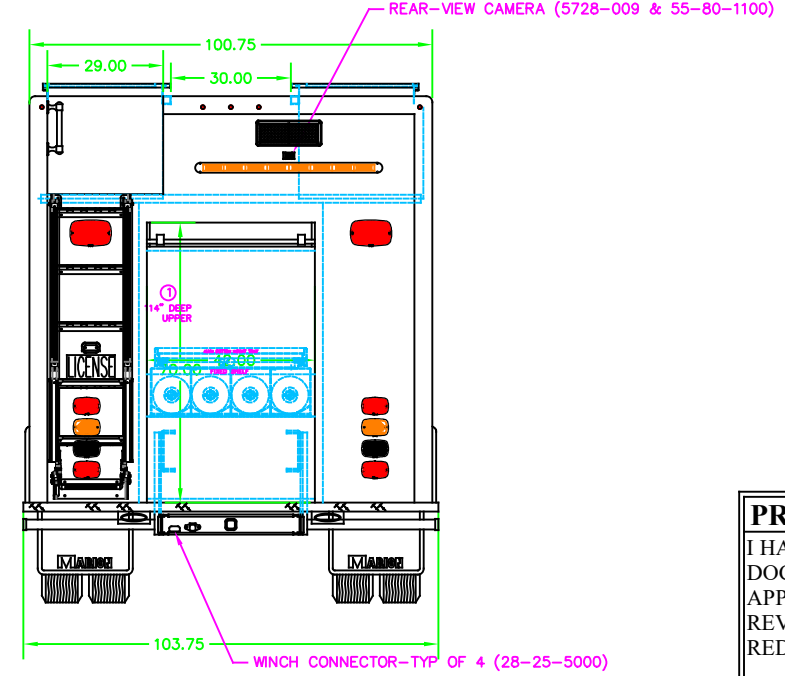

**REAR VIEW**

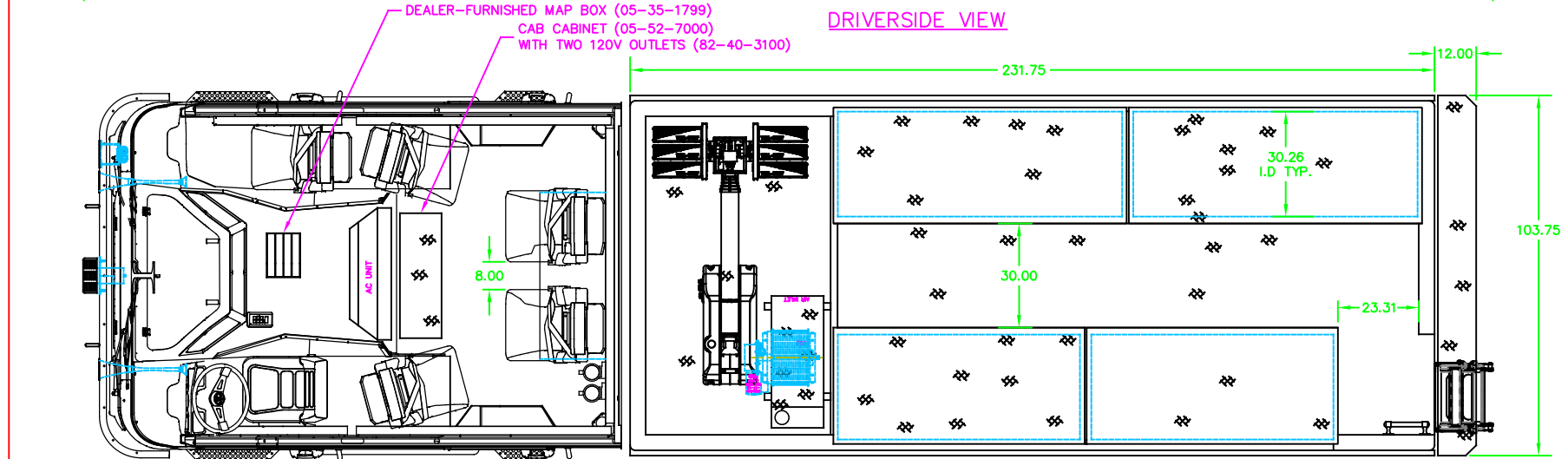

**TOP VIEW**

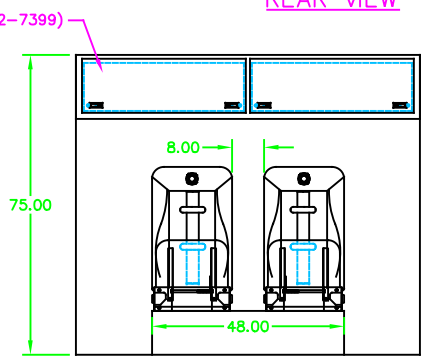
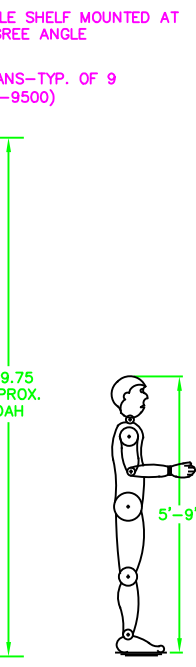

**CAB CABINET (05-52-7399)**  
(ALL DIMENSIONS APPROXIMATE)

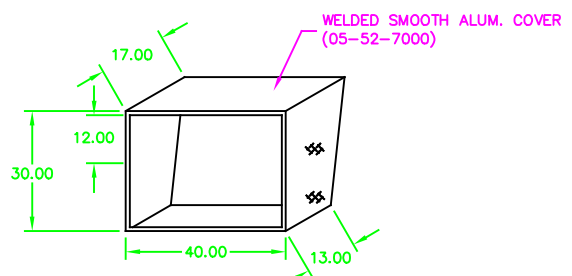

**CAB CABINET (05-52-7000)**  
(ALL DIMENSIONS APPROXIMATE)

**PRINT APPROVAL**  
I HAVE EXAMINED THIS DOCUMENT AND APPROVE IT WITH NOTED REVISIONS, IF ANY, IN RED.  
SIGNATURE \_\_\_\_\_  
DATE \_\_\_\_\_

9526Q MBW JOB NUMBER

MAXIMUM OVERALL LENGTH 42' OR 35' (33-49-1000)  
NO MAXIMUM OVERALL HEIGHT SPECIFIED (33-49-2000)

C	12/18/23	GRS	DELETED REAR LADDER/STOKES STORAGE	CHASSIS SPECS	<b>MARION</b>	MARION BODY WORKS, INC. P.O. BOX 500 MARION WISCONSIN 54950-0500 715/754-5261 FAX 715/754-5776
B	5/28/23	GRS	REVISED PER PRE-BUILD MEETING (GRND & MARKER LIGHTS)	CHASSIS	<b>SPARTAN</b>	TITLE 19" RESCUE VEHICLE
A	4/5/23	GRS	REVISED PER SALES MARK-UP	MODEL	<b>GLADIATOR</b>	FOR CUBA CITY, WI
LTR	DATE	BY	DESCRIPTION	BY	DATE	SCALE 1/20
			MARION RESERVES THE RIGHT TO MAKE MINOR DIMENSIONAL CHANGES, AND DESIGN AND COMPONENT CHANGES FOR PRODUCT IMPROVEMENT	213.51146"	11/9/22	SHEET 1 OF 1